

INSPIRATION  
SERIES



**M<sup>3</sup> IN-GROUND  
MODULAR CHANNEL LIGHT**

Low Energy. Low Maintenance.  
Low Heat. Long Life.



IP67



**IK10**

Lamps can bear more than  
**2000lbs**

Integrated high-power  
**LED**

**IP67**

## **IN-GROUND MODULAR CHANNEL LIGHT**

This linear and waterproof LED light can be mounted in a floor or wall. Due to its small size (1.4-1.6" wide and 2.6" tall) it can adapt to a variety of spaces. Quick and easy to install, this series has optional accessories that create a variety of shapes to allow the versatility and creative freedom designers need.

Its lightweight and durable body is made from high-strength casted aluminum. The lamp is sealed by reinforced glass, a rubber ring, and silicone to prevent water damage. Hardened glass is used to resist extreme temperature, impact, friction, and pressure. Light transmittance is as high as 92% and the product can withstand over 2,000 lbs of weight .

[www.SARINEnergy.com](http://www.SARINEnergy.com)

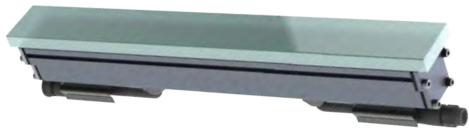

**1' Titan Module**  
7.5W, 375lm, 11.8" Length

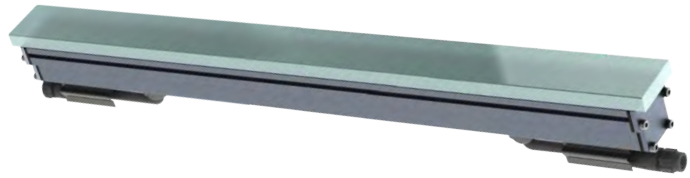

**2' Titan Module**  
15W, 750lm, 22.8" Length

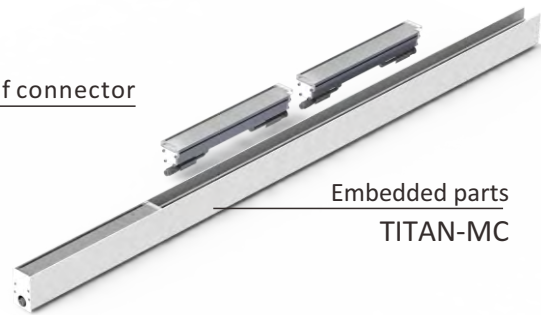
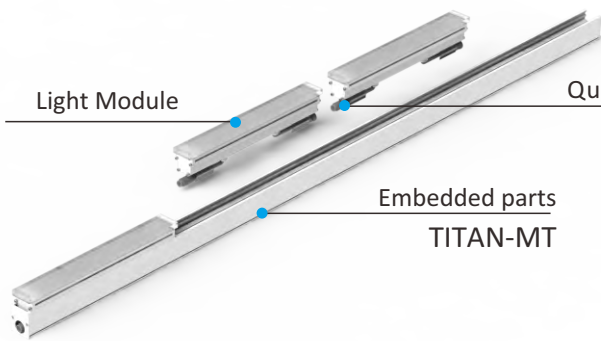

**Two kinds of embedded part installation renderings**

TITAN-MT

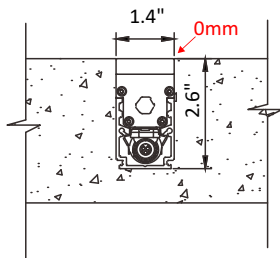

TITAN-MC

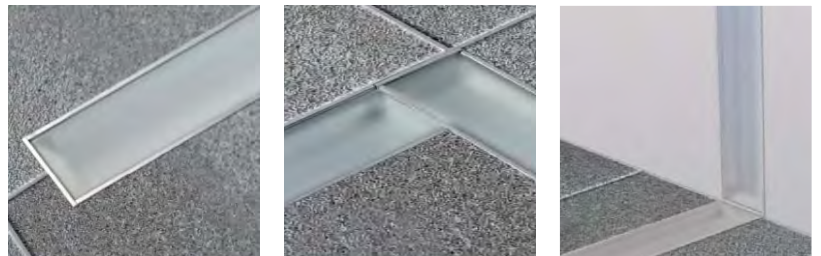
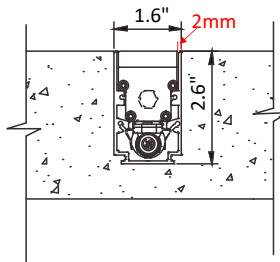



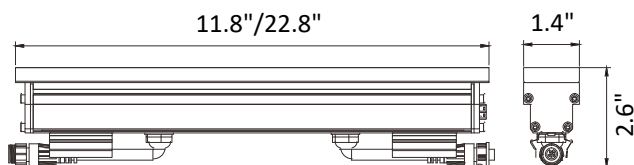









**Quick waterproof connector**



LED

## Product List

- LED chip: **PHILIPS**
- Driver brand:   certification
- CRI >80
- Life 50,000h
- Color temperature:  
Cool white 6500K  
Neutral white 4000K  
Warm white 3000K  
Red, Blue, or Green

| Item No.  | Power                 | Size   | Image   |
|---|-----------------------|--|---|
| SES-TITAN-7.5   | 7.5W                  | 1.4" x 2.3" x 11.8"                                  |  |
| SES-TITAN-15  | 15W                   | 1.4" x 2.3" x 22.8"                                  |  |
| SES-TITAN-MT  | Light Base (Trimless) | 1.4" x 1.7" x 11.8" / 22.8" / 44.6" / 94.5" / 118.1" |  |
| SES-TITAN-MC  | Light Base (Trim)     | 1.6" x 2.6" x 11.8" / 22.8" / 44.6" / 94.5" / 118.1" |  |
|  Drivers | 100W / 150W / 200W    |  |  |
| SES-TITAN-MT-End-Cap  |                       |  |  |
| SES-TITAN-MC-End-Cap  |                       |  |  |
| SES-TITAN-Cable   |                       | 39.4" / 78.7"  |  |
| SES-TITAN-Bolt-S  |                       |  |  |
| SES-TITAN-90°-Connector   |                       |  |  |
| SES-TITAN-180°-Connector  |                       |  |  |
| SES-TITAN-Driver-Box  |                       |  |  |





## Installation

### 1. EMBEDDED IN EXISTING MASONRY

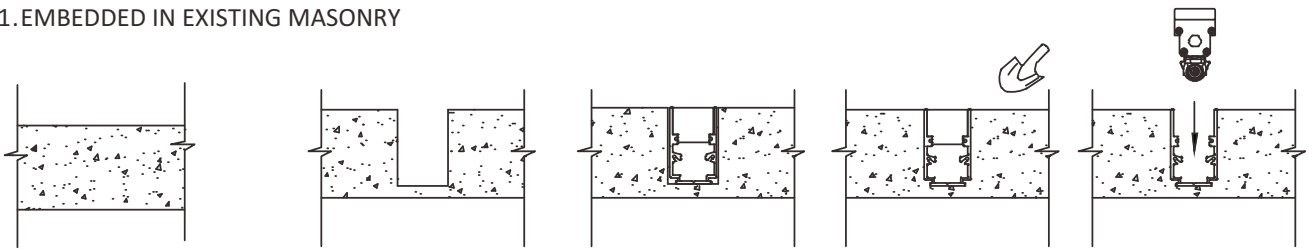

### 2. EMBEDDED IN FRESH CONCRETE

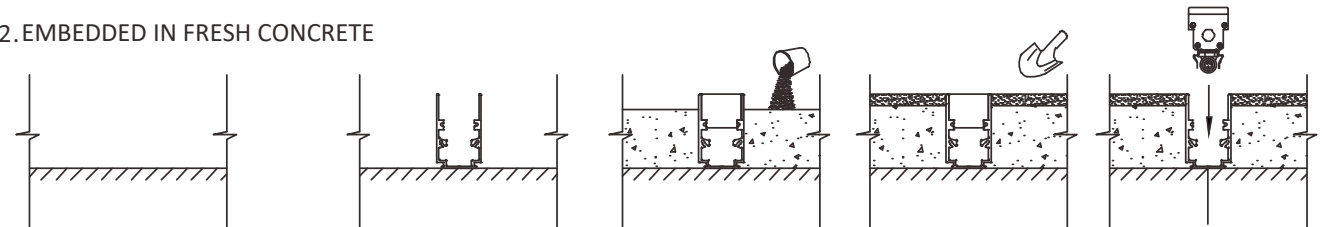

### 3. SURFACE MOUNTED ON THE GROUND OR WALL

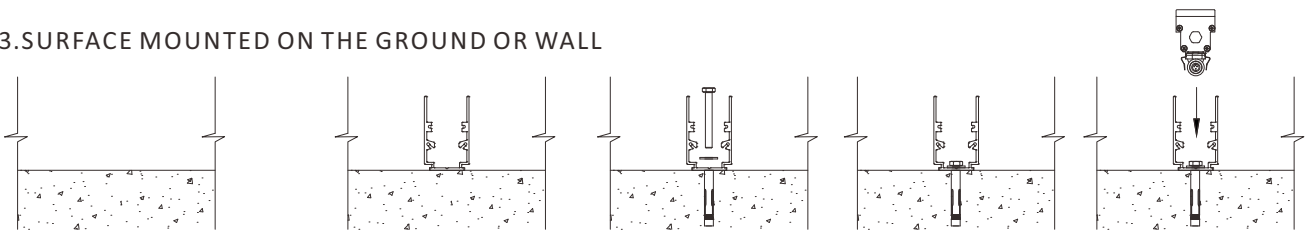

## WARNING

Do the construction without groundwater infiltration, the light cannot function if it gets wet.



Embedded parts installation  
Optional accessories package

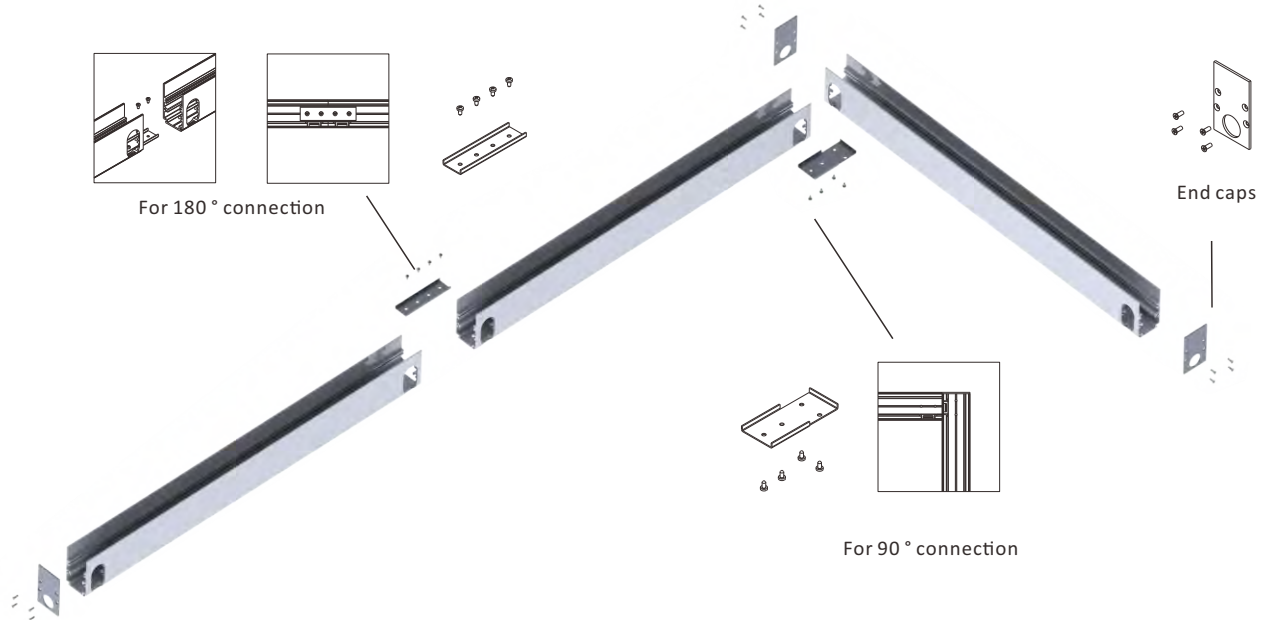

Monochrome Wiring Diagram

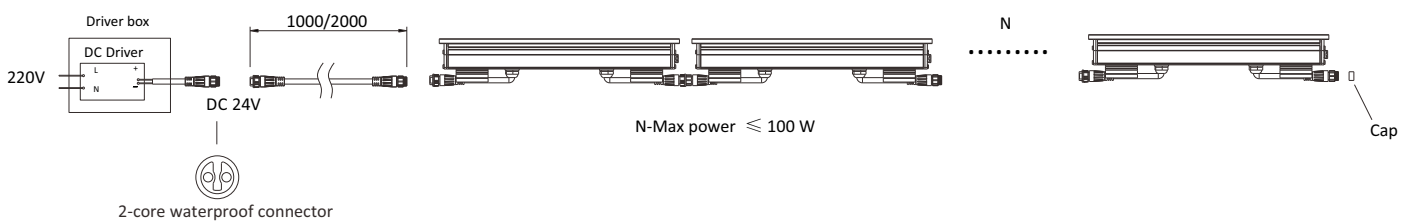

Can be used as a  
STEP LIGHT & WALL LIGHT

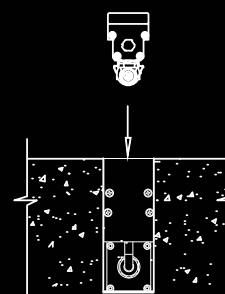
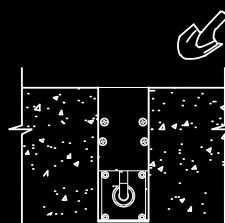
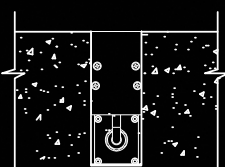
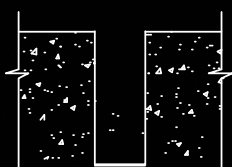
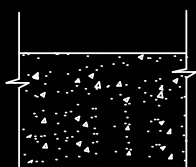
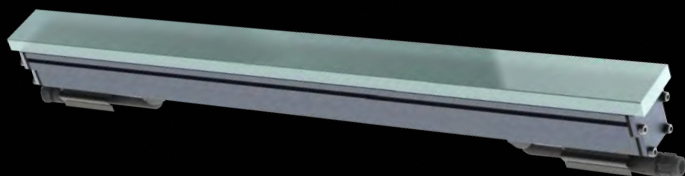
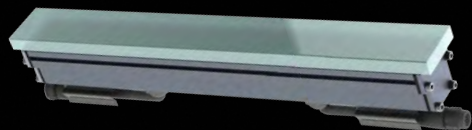



☎ 855-997-2746

📠 888-671-4872

✉ LED@SARINEnergy.com

🌐 SARINEnergy.com